

Distribuidor Autorizado

SurteRápido.com

Venta de Refacciones
Electrodomesticas

LAE1020PB0

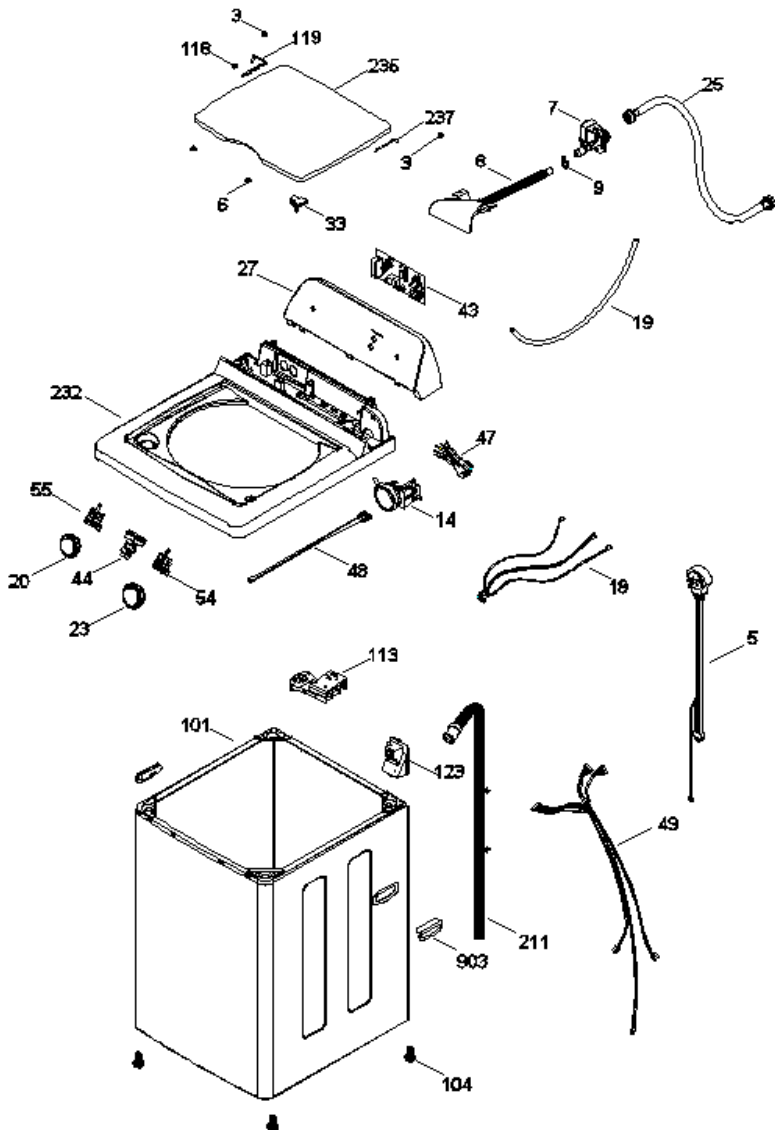

LAE1020PB0

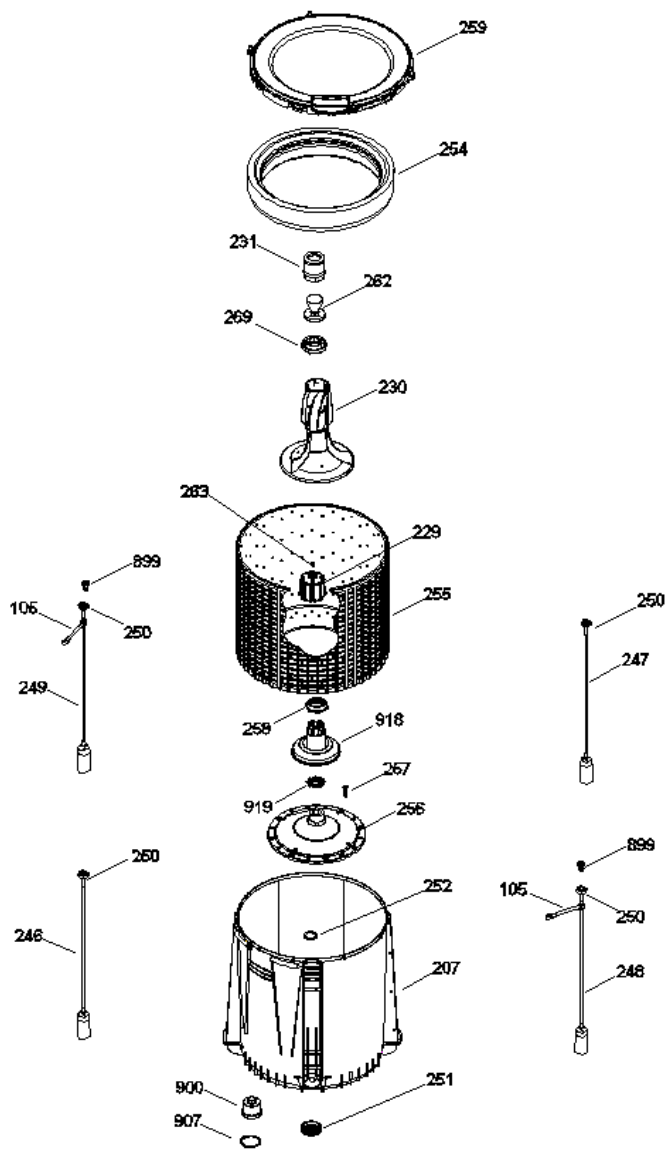

LAE1020PB0

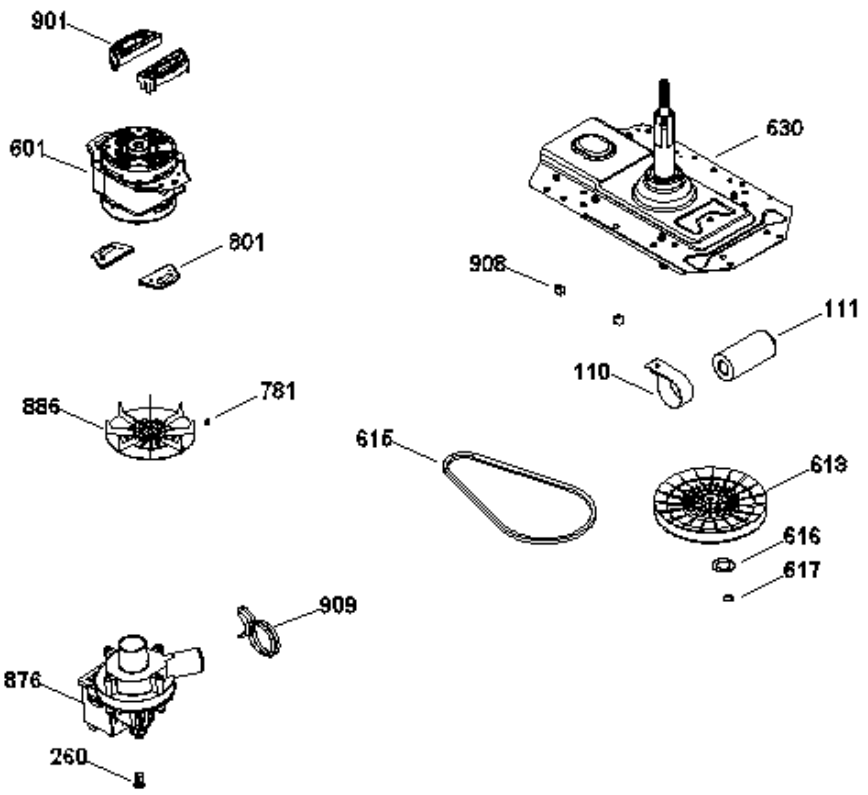



LAE1020PB0

8	323B2198P006	MANGUERA ENTRADA DE AGUA (S/P)
9	109B8787P014	ABRAZADERA ENTRADA DE AGUA (S/P)
14	8102324	PRESOSTATO (SELECTOR)
18	189D3636G001	ARNES GABINETE 10,12,13KG SIS (S/P)
19	323B1277P001	MANGUERA PRESOSTATO CORTA IMP (S/P)
20	189D3778G003	ENS. PERILLA ROTATORIA COPETE. (S/P)
23	189D3777G003	ENS. PERILLA CONTROL COPETE E. (S/P)
25	141A6384G058	MANGUERA LLENADO AGUA CALIENTE (S/P)
27	189D3813G004	ENS. COPETE-HT 2P BCO 10KG ECO (S/P)
33	228C2201P001	ACTUADOR TAPA CURVA (S/P)
43	8183634	TARJETA PERILLAS 2P 9KG LOW CO
44	8102762	TARJETA BOTONES
47	189D3642G002	ARNES CUBIERTA SIS 10Y12KG 2P (S/P)
48	189D3652G001	ARNES PRESOSTATO 4 NIVELES (S/P)
49	189D3820G001	ARNES SEL. 10,12KG 2P SIS LOW (S/P)
54	8102140	SELECTOR 8 POSICIONES
55	228C2139G004	SELECTOR 4 POSICIONES LOW COST (S/P)
101	189D2564G001	GABINETE ENSAMBLE (S/P)
104	228C2081P001	PATA NIVELADORA (S/P)
105	228C2119P002	LIGA DE SUSPENSION (S/P)
110	228C1155P001	ABRAZADERA CAPACITOR WEG 15,4 (S/P)
111	7201121	CAPACITOR WEG 45 MF
113	7122107	BLOCAPUERTAS C/SLIDER A 90 NVO
118	323B1294P001	TAPON BISAGRA (S/P)
119	7011037	BISAGRA DE ALAMBRE (LARGA)
123	189D2637P001	TAPA MANGUERRA DE SALIDA (S/P)
207	189D2917G001	ENS TINA VS SELLOS 8KG AMAZONA (S/P)
211	228C2206G001	MANGUERA DE DRENADO (S/P)
229	189D3624P001	COPELE AGITADOR (S/P)
230	189D3745G001	ENSAMBLE AGITADOR 9 KG. (S/P)
231	7431004	TAPA AGITADOR F.S.D.
232	189D2963P001	CUBIERTA ECO 9 KG. (S/P)
235	189D4112G001	ENSAMBLE TAPA BLANCA SUBLIMADO (S/P)

237	123C8029P001	BISAGRA DE ALAMBRE (CORTA) (S/P)
246	189D1970G027	SUSP.9 KG FRON.DER.LOW COST (S/P)
247	189D1970G028	SUSP.9 KG POST.LOW COST (S/P)
248	189D1970G025	ENS. SUSP. 9KG FRONTAL LOW COS (S/P)
249	189D1970G026	ENS. SUSP. 9KG POSTERIOR LOW C (S/P)
250	7011043	ROTULA SUPERIOR
251	8102113	SELLO TINA
252	323B2127P001	ARANDELA FONDO CANASTA (S/P)
254	7451004	ARO BALANCE ENS.
255	189D1007P001	CANASTA (S/P)
256	189D3533P001	FONDO CANASTA (S/P)
257	8911238P041	TORNILLO FONDO CANASTA (S/P)
258	8102160	TUERCA TINA
259	189D3651P001	CUBIERTA TINA (S/P)
260	8102090	SELLO BOMBA
262	7431009	COPA DESP. SUAVIZANTE
263	8151346	TORNILLO C/GROMET COPLE (S/P)
269	7431010	DOSIFICADOR SUAVISANTE (S/P)
601	8102643	MOTOR BALEROS 1/4
613	8102652	POLEA TRANSMISION
615	8102120	BANDA 3L V
616	323B2052P001	ARANDELA DE FRICCION (S/P)
617	7192012	ANILLO DE RETENCION
630	189D3593G002	ENS. TX CON SOPORTE (S/P)
781	323B1279P002	OPRESOR POLEA (S/P)
801	323B2167P001	REFUERZO MOTOR AMAZ (S/P)
876	8102600	BOMBA DESAGUE 25
886	189D2645G005	ENS. POLEA MOTOR 11KG LOW COST (S/P)
899	228C2207P001	BUJE LIGA (S/P)
900	228C2089P001	TAPON CAJA PRESOSTATO TINA (S/P)
901	228C2112P001	ESPACIADOR MOTOR (S/P)
903	228C2118P001	JALADERA PARA GABINETE (S/P)
907	8102098	SELLO TAPON TINA
908	323B2099P001	CLIP TAPON PRESOSTATO (S/P)
909	323B1390P001	ABRAZADERA BOMBA DOBLE HILO (S/P)
918	189D3590G001	ENSAMBLE FLOTADOR
919	228C2315P001	EMBRAGUE FIJO (S/P)