

LAE500B

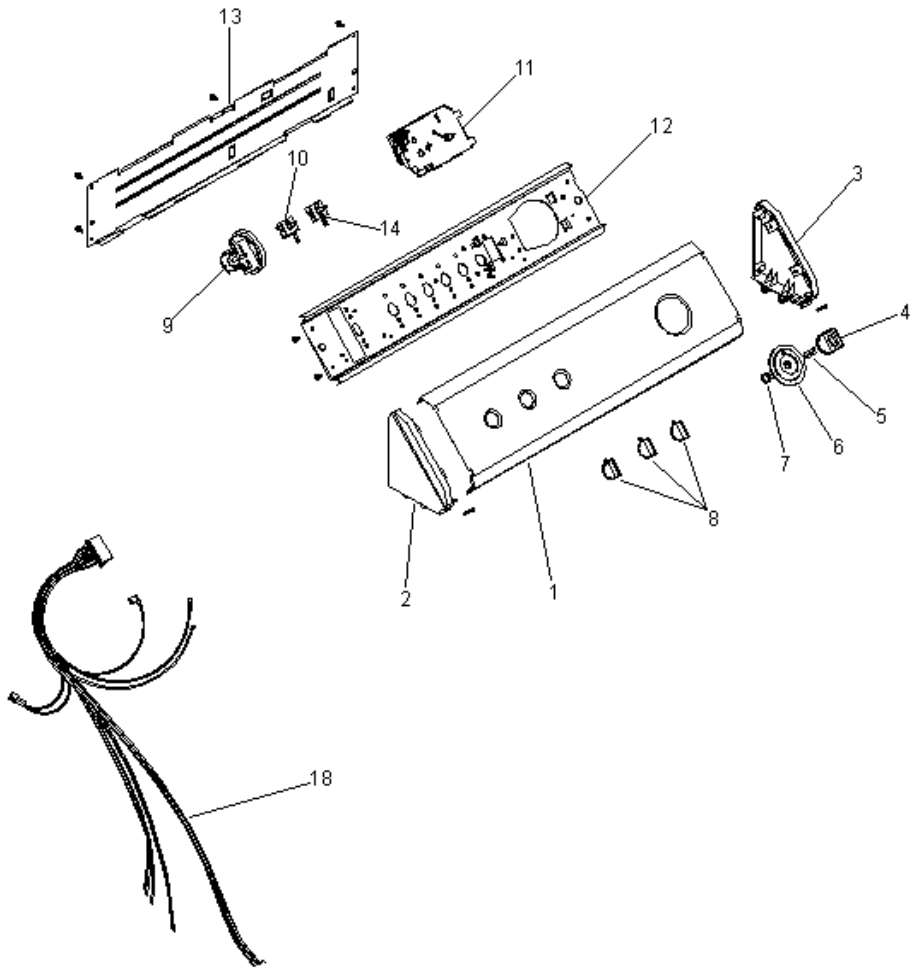

LAE500B

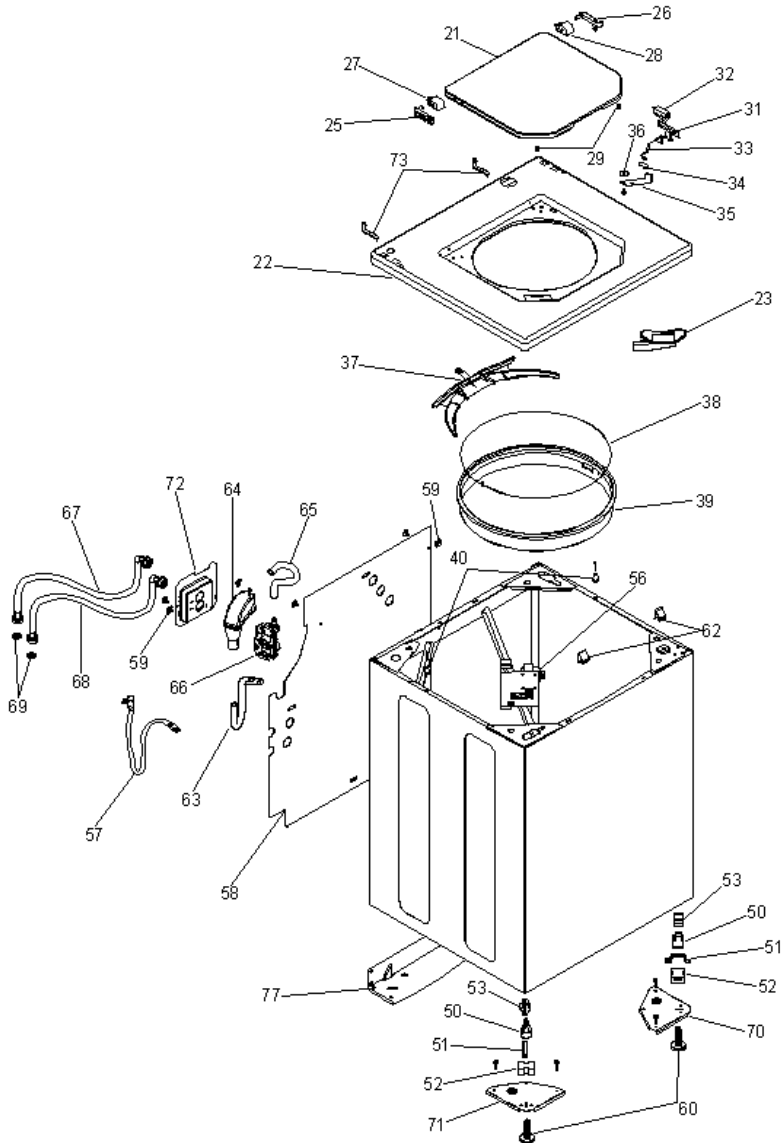

LAE5000B

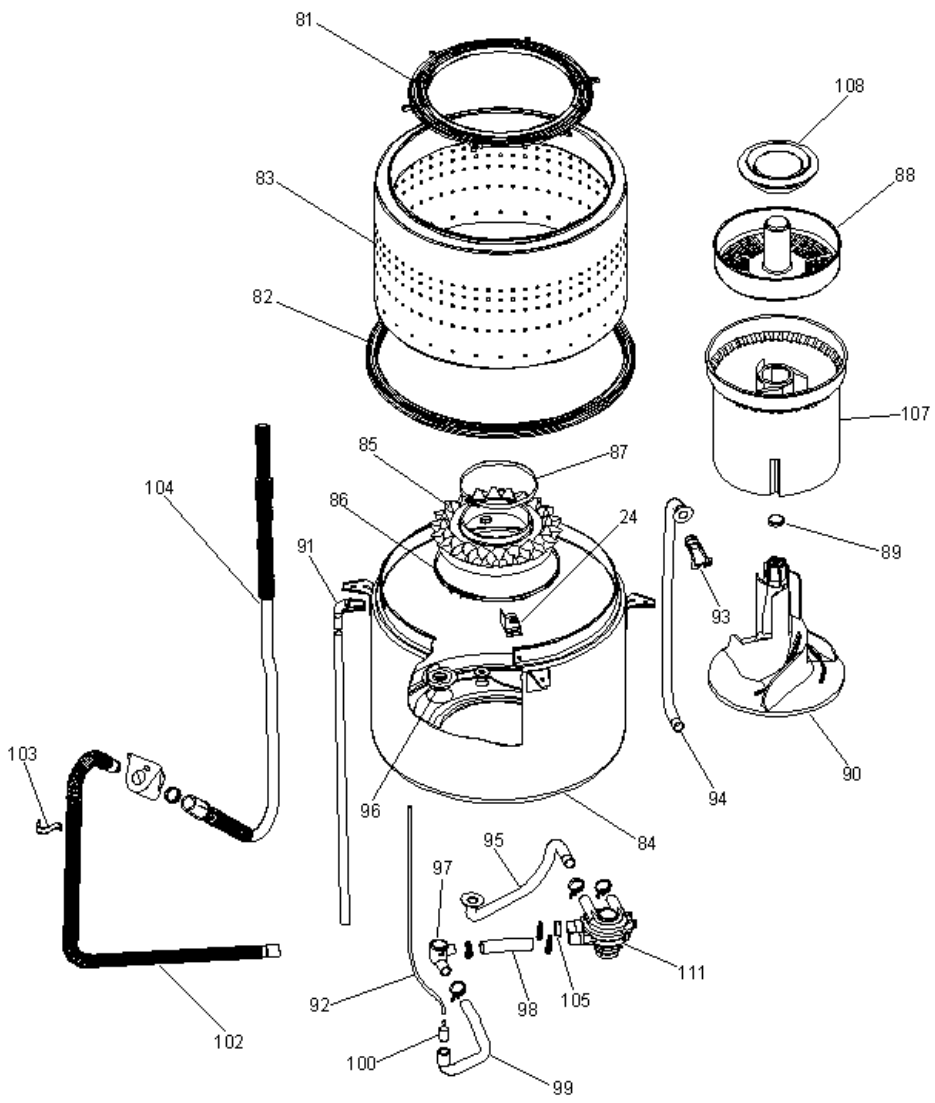

LAE500B

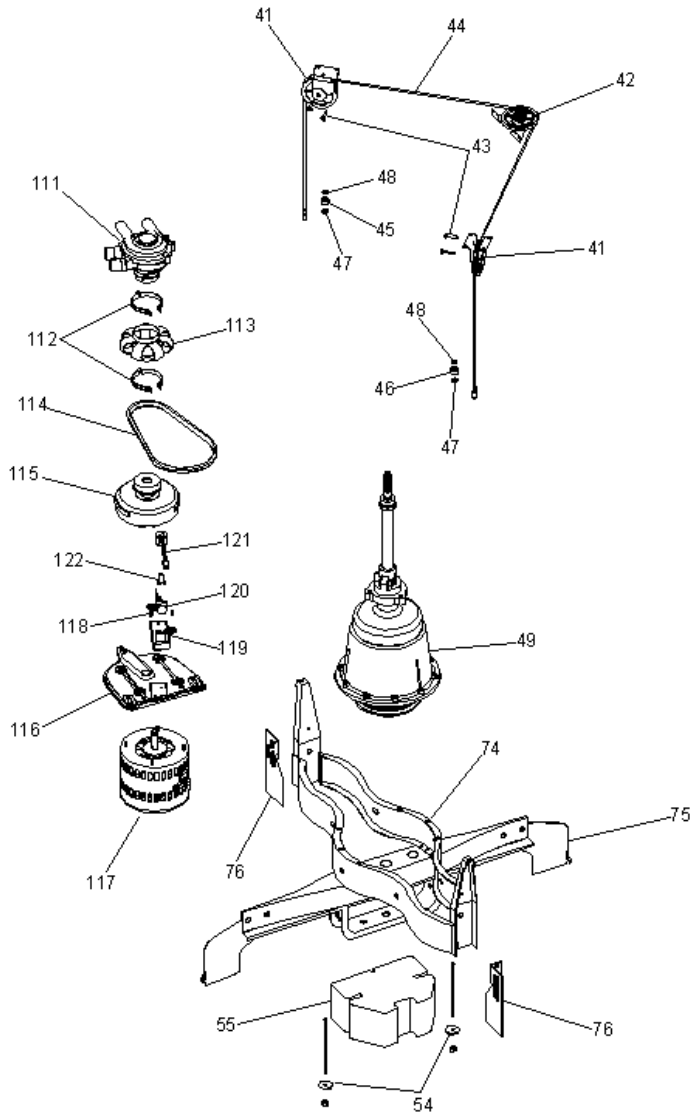



LAE5000B

1	3707001	VISTA TABLERO DESCONTINUADO
2	3557003	LATERAL TABLERO IZQ. (BCO.) DESCONTINUADO
3	3557004	LATERAL TABLERO DER. (BCO.) DESCONTINUADO
4	3666006	PERILLA CONTROL TIEMPO (BCA.) (S/P)
5	655171	CANDADO PERILLA CONTROL DESCONTINUADO
6	3562002	CARATULA (BCO.) DESCONTINUADO
7	655228	CANDADO DISCO INDICADOR (S/P)
8	3270012	ENS. PERILLA ROTATORIA (BCA.) (S/P)
9	3548005	PRESOSTATO 3 NIVELES (S/P)
10	3549002	INTERRUPTOR TEMP. 3 POSIC. DESCONTINUADO
11	3576001	CONTROL DE TIEMPO (127 V.) DESCONTINUADO
12	3885005	SOPORTE CONTROLES (S/P)
13	3884002	TAPA TABLERO (S/P)
18	3574002	ARNES 1 VEL. (S/P)
21	3399157	ENSAMBLE TAPA CUBIERTA (BCA.) (S/P)
22	3159013	ENS. CUBIERTA S/DOSIF. (BCA.) (S/P)
25	3142006	BISAGRA IZQ.
26	3142005	BISAGRA DER.
27	3141005	PIVOTE BISAGRA IZQ. DESCONTINUADO
28	3141007	PIVOTE BISAGRA DER. (S/P)
29	3874003	AMORTIGUADOR TAPA, CORTO (S/P)
31	3524004	SOPORTE INTERRUPTOR TAPA (S/P)
32	3071001	ENS. INTERRUPTOR TAPA DESCONTINUADO
33	3143001	ACTUADOR INTERRUPTOR TAPA DESCONTINUADO
34	3033001	BOTON ACTUADOR (S/P)
35	3032001	SOPORTE ACTUADOR (S/P)
36	3072001	RONDANA DE PLASTICO DESCONTINUADO
37	3145008	RETEN ALETON DESCONTINUADO
38	3861004	ALAMBRE ALETON ALUM. (S/P)
39	WH8X366	ALETON CUBIERTA
40	3061003	GUIA CUBIERTA (S/P)
41	3053002	ENS. POLEA VERTICAL Y SOPORTES
42	3052001	ENS. POLEA HORIZONTAL Y SPTES.
43	3006001	PASADOR POLEA (S/P)
44	3028011	ENS. CABLE SUSPENSION DESCONTINUADO

45	3048003	COPA CABLE (NGO.) DESCONTINUADO
46	3048004	COPA CABLE (BCO.) (S/P)
47	3042002	CANDADO ASIENTO CABLE DESCONTINUADO
48	3165022	CANDADO RETEN CABLE (S/P)
49	910999000	ENS. TRANSMISION DESCONTINUADO
50	3389003	YUGO DESCONTINUADO
51	3043001	ABRAZADERA YUGO DESCONTINUADO
52	3387002	AMORTIGUADOR YUGO DESCONTINUADO
53	3954002	COJIN FRICCION (S/P)
54	3080001	ESPACIADOR CONTRAPESO (S/P)
55	3331001	CONTRAPESO 1 VEL. DESCONTINUADO
57	3132007	CABLE ALIMENTACION (S/P)
58	3139014	TAPA TRASERA DESCONTINUADO
59	3082001	CLIP TAPA TRASERA DESCONTINUADO
60	3800002	TORNILLO NIVELADOR (S/P)
62	3078002	CLIP CUBIERTA (S/P)
63	3157002	BOQUILLA ENTRADA AGUA (S/P)
64	3092002	ENS. ENTRADA AGUA
65	3007008	MANGUERA VALVULA ENTRADA (S/P)
66	3146010	ENS. VALVULA DE AGUA (127 V.) (S/P)
67	656933	ENS. MANG. LLENADO AGUA FRIA (S/P)
68	656941	ENS. MANG. LLENADO AGUA CAL. (S/P)
69	3085001	RONDANA Y FILTRO (S/P)
70	3447001	ENS. ESQUINERO INF. DEL. DER. (S/P)
71	3447002	ENS. ESQUINERO INF. DEL. IZQ. (S/P)
72	3752003	SOPORTE VALVULA (S/P)
73	3057002	TIRANTE CUBIERTA (S/P)
74	3113006	ENS. SUSPENSION DESCONTINUADO
75	3069003	ENS. SOPORTE Y ALETAS (S/P)
76	3027004	ALETA SUSPENSION (S/P)
77	3030004	ENS. BASE TRASERA (S/P)
81	3152002	PROTECTOR ROPA
82	3799007	EMPAQUE TINA (S/P)
83	3801009	ENS. CANASTA Y MAGNETITA 7 KG (S/P)
84	3108005	ENSAMBLE TINA 7 KG (S/P)
85	3225002	BOTA MECANICA
86	3093006	ABRAZADERA BOTA, GRANDE
87	3114012	ABRAZADERA BOTA, CHICA DESCONTINUADO
88	3792001	FILTRO DE RECIRCULACION AZUL DESCONTINUADO

89	3209008	TAPON AGITADOR
90	3680003	ENS. AGITADOR Y COPLE (S/P)
91	3037001	BOQUILLA DERRAME
92	3059011	MANGUERA PRESOSTATO (S/P)
93	3018013	BOQUILLA RECIRCULACION (S/P)
94	3828006	MANGUERA DE RECIRCULACION (S/P)
95	3797006	MANGUERA ENTRADA RECIRCULACION (S/P)
96	3337001	ADAPTADOR CODO DESAGUE (S/P)
97	3334003	CODO DESAGUE DESCONTINUADO
98	3338001	MANGUERA DESALOJO DESCONTINUADO
99	3339002	MANGUERA CAMARA DE AIRE
100	3003001	REDUCCION MANGUERA (S/P)
102	3196001	MANGUERA DESAGUE INTERIOR
103	3054004	SOPORTE MANGUERA DESAGUE (S/P)
104	3197001	MANGUERA DESAGUE EXTERIOR (S/P)
105	3798008	ADAPTADOR MANGUERA (S/P)
111	WH23X42	BOMBA ENS.
112	3051001	ABRAZADERA COPLE FLEXIBLE (S/P)
113	WH17X22	COPLE FLEXIBLE
114	WH1X2026	BANDA
115	3468001	ENSAMBLE CLUTCH 1 VEL. (S/P)
116	3039004	MONTURA MOTOR (S/P)
117	3161003	MOTOR (127 V./ 60 Hz.) DESCONTINUADO