

Marca		Whirlpool	
Capacidad		14 pies	
Color		Stainless Steel	
Gabinete			
R e f	Descripción	C a n t	Numero de Parte
1	Cabinet Parts	*	*****
2	Screw	*	*****
3	Cover, Hinge	*	*****
4	Hinge, top	1	W10346928
5	Filler, Corner (Izquierda)	1	W10516216
	Filler, Corner (Derecha)	1	W10516210
6	Washer	1	487576
7	Hinge, Center	1	W10492014
8	Washer	1	489341
9	Hinge-Pin, Bottom	1	2325483
10	Hinge-Butt, Bottom	1	W10621245
11	Leg Leveler	2	W10340017

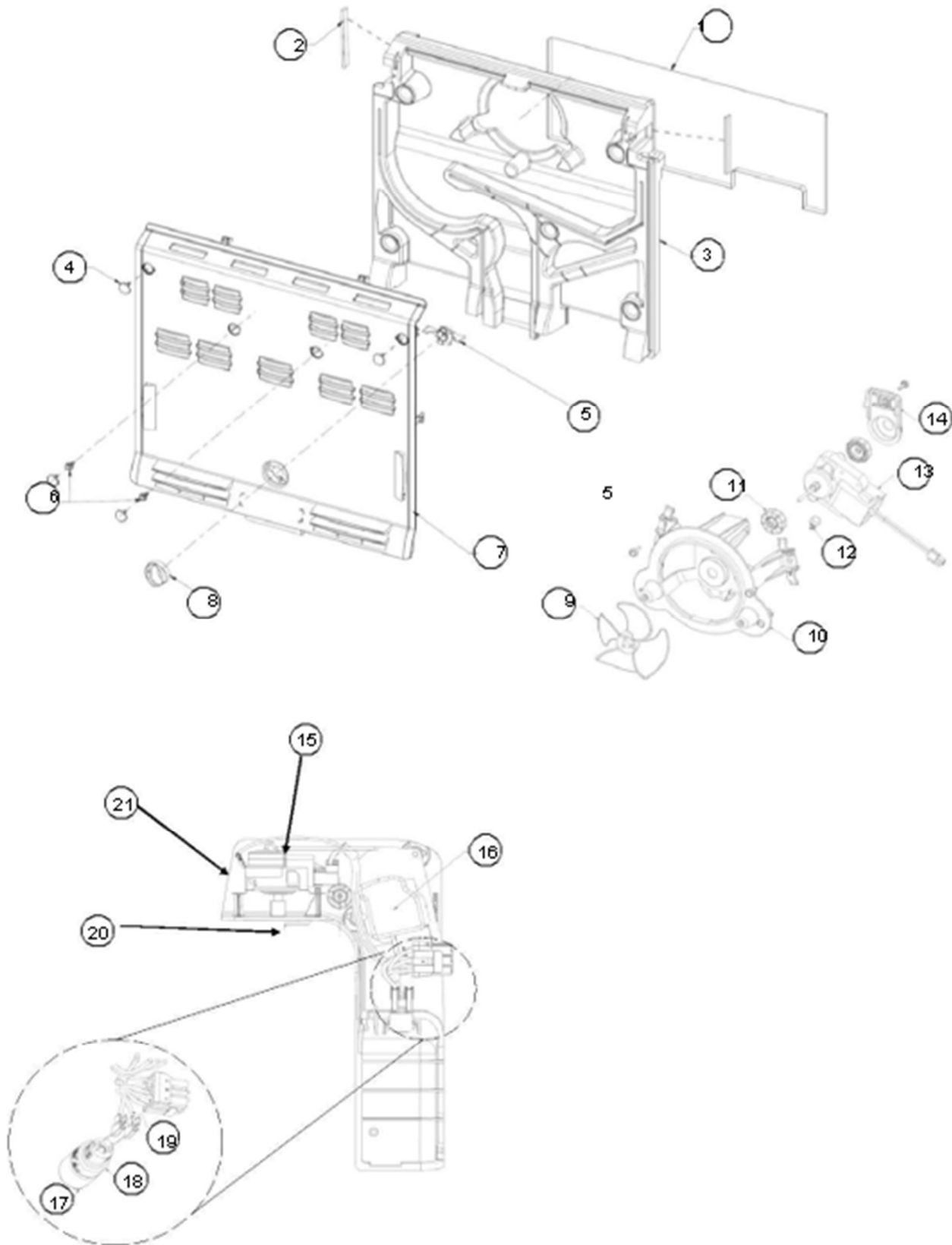

Marca		Whirlpool	
Capacidad		14 pies	
Color		Stainless Steel	
Sistema Flujo de Aire			
R e f	Descripción	C a n t	Numero de Parte
1	Shield, Plenum	1	W10345816
2	Foam Seal	*	*****
3	Evaporator, Back Cover	1	W10420509
4	Screw, Cover	1	W10487421
5	Flap	1	W10743057
6	Screw	*	*****
7	Cover Plastic, Plenum FC	1	W10514231
8	Knob, Freezer Control	1	W10465177
9	Fan Blade	1	2200509
10	Frame, Fan Motor	1	W10261254
11	Grommet	1	W10225833
12	Cushiong, Jamb-Damping	1	W10225835
13	Evaporator Fan, Motor	1	W10253821
14	Motor, Support	1	W10251274
15	Thermostat	1	W10530058
16	Defrost, Timer	1	W10844633
17	Light 25 Watts	1	W10809513
18	Lampholder	1	W10545295
19	Wire, Control Box	1	W10412780
20	Knob, Refrigerator Control	1	W10465179
21	Control Box	1	W10358069

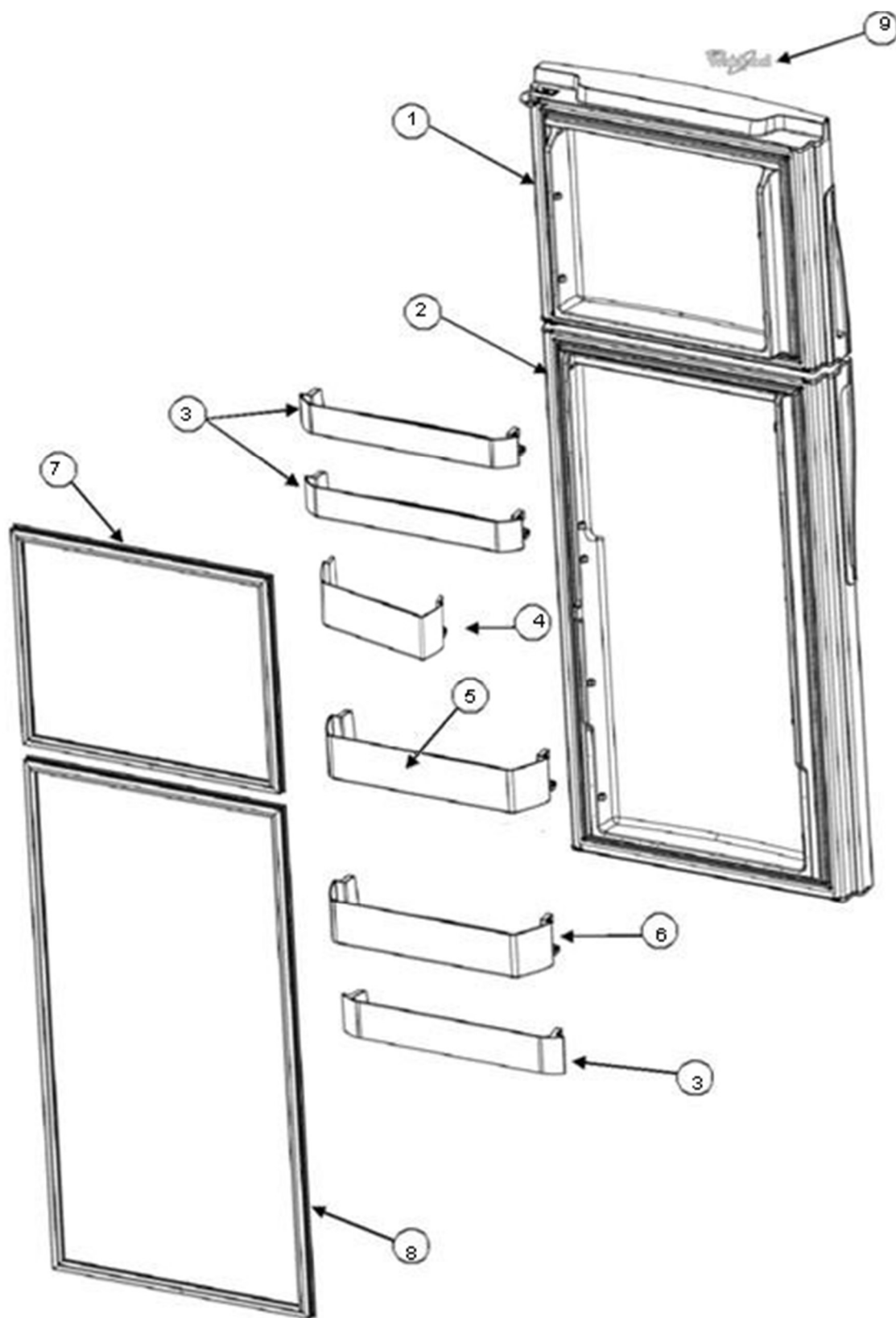

Marca		Whirlpool	
Capacidad		14 pies	
Color		Stainless Steel	
Puertas			
R e f	Descripción	C a n t	Numero de Parte
1	Door, Assy (FC)	1	LW1067666
2	Door, Assy (RC)	1	LW10676674
3	Trivet, Door	3	W10625817
4	Bin, Utility	1	W10702855
5	Bin, Door Shallow (RC)	1	W10364007
6	Bin, Gallon	1	W10364008
7	Gasket, Door (FC)	1	W10507442
8	Gasket, Door (RC)	1	W10632947
9	Nameplate	1	W10481433

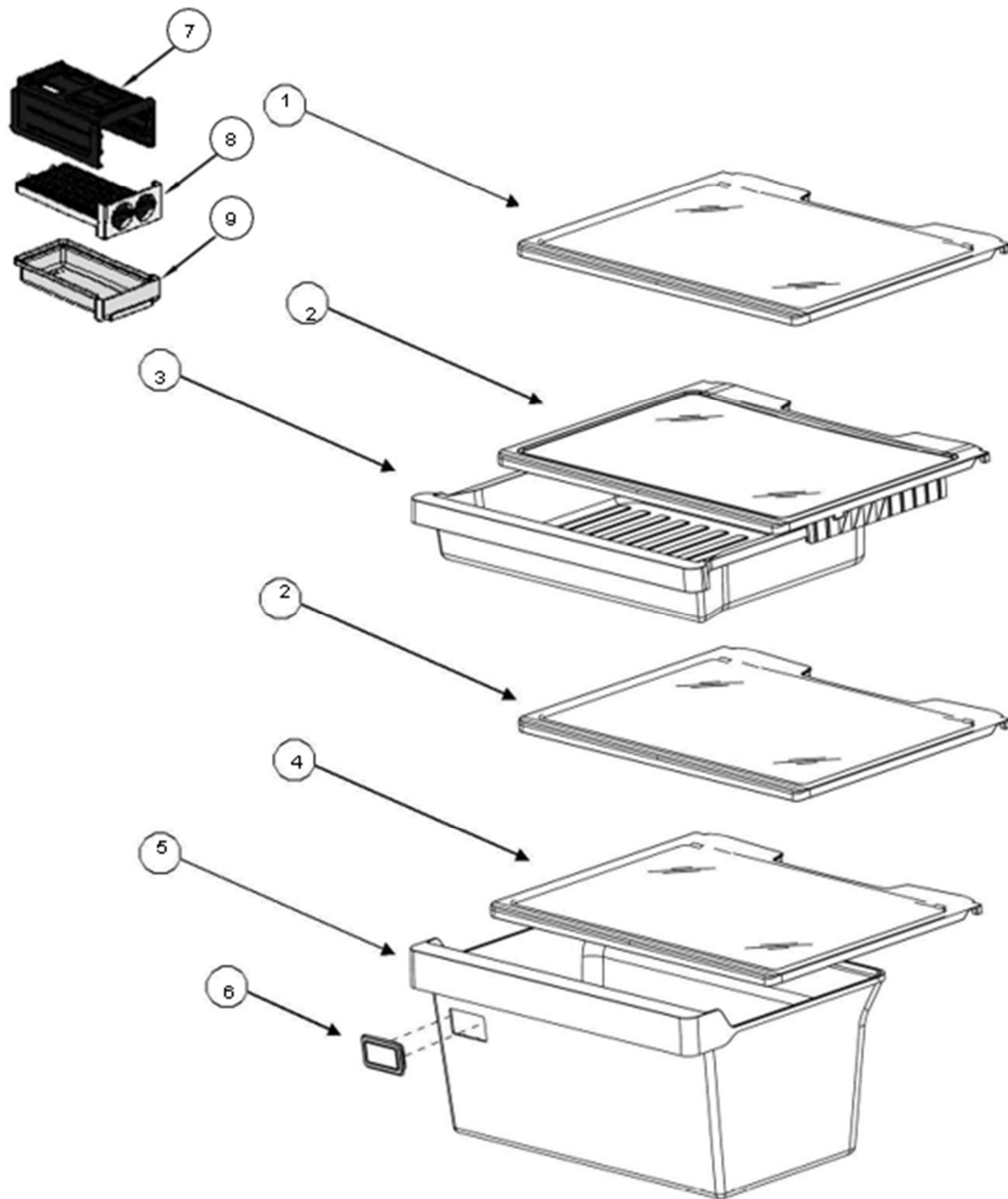

Marca		Whirlpool	
Capacidad		14 pies	
Color		Stainless Steel	
Anaqueles			
R e f	Descripción	C a n t	Numero de Parte
1	Shelf, Assy FC (Plastic)	1	W10896170
2	Shelf, Assy RC (Glass)	2	W11046410
3	Meat Pan	1	W10340890
4	Cover, Crisper Pan	1	W11046442
5	Crisper Pan	1	W10503244
6	Control, Humidity	*	*****
7	Soporte, Twist Ice	1	2265367
8	Charola, Twist Ice	1	W10304316
9	Cajón, Twist Ice	1	W10636395

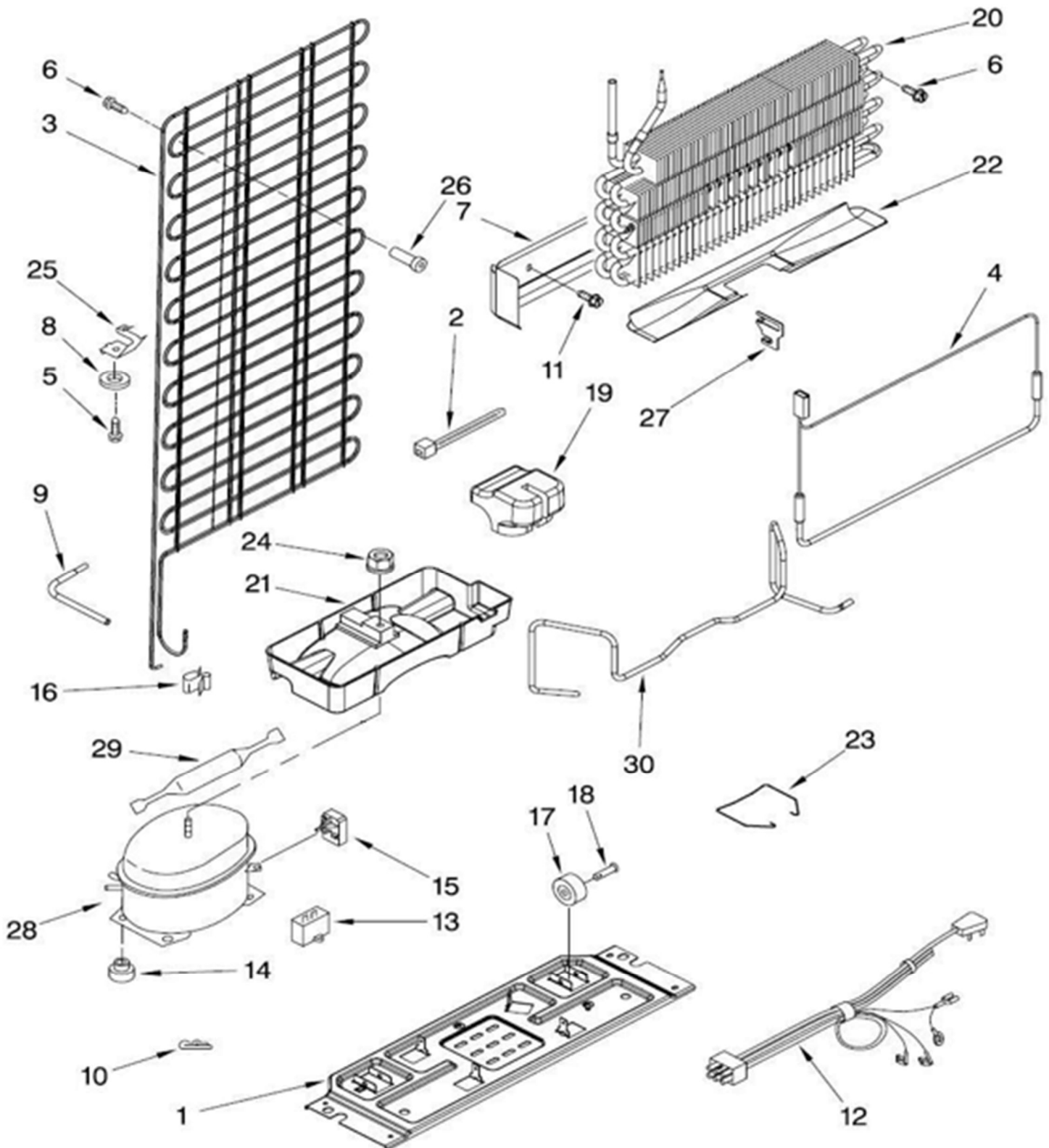

Marca		Whirlpool	
Capacidad		14 pies	
Color		Stainless Steel	
Sistema Sellado			
R e f	Descripción	C a n t	Numero de Parte
1	Support Plate, Compressor	1	W10378704
2	Strap	1	2263990
3	Condenser	1	W10439364
4	Heater, Defrost	1	W10331598
5	Screw	*	*****
6	Screw	*	*****
7	Heat Shield	1	W10345815
8	Washer	*	*****
9	Tube, Process	*	*****
10	Clip Compressor	*	*****
11	Screw	*	*****
12	Power, Cord	1	W10718208
13	Capacitor	*	*****
14	Grommet	4	2264447
15	Combo, Device	1	W10796752
16	Clip, Wire	*	*****
17	Roller	2	W10475495
18	Axle, Rivet	2	2179826
19	Wedge, Evaporator	2	W10261299
20	Evaporator Assy	1	W10502224
21	Evaporator Tray	1	W10767486
22	Drain Pan	*	*****
23	Bale Strap	1	W10174383
23a	Cap, Combo	1	W10642075
24	Hex Nut	*	*****
25	Clip, Condenser Mounting	*	*****
26	Support, Condenser	4	326020544
27	Bracket	*	*****
28	Compressor	1	W10743447
29	Drier	1	W10669573
30	Tube Discharge	*	*****

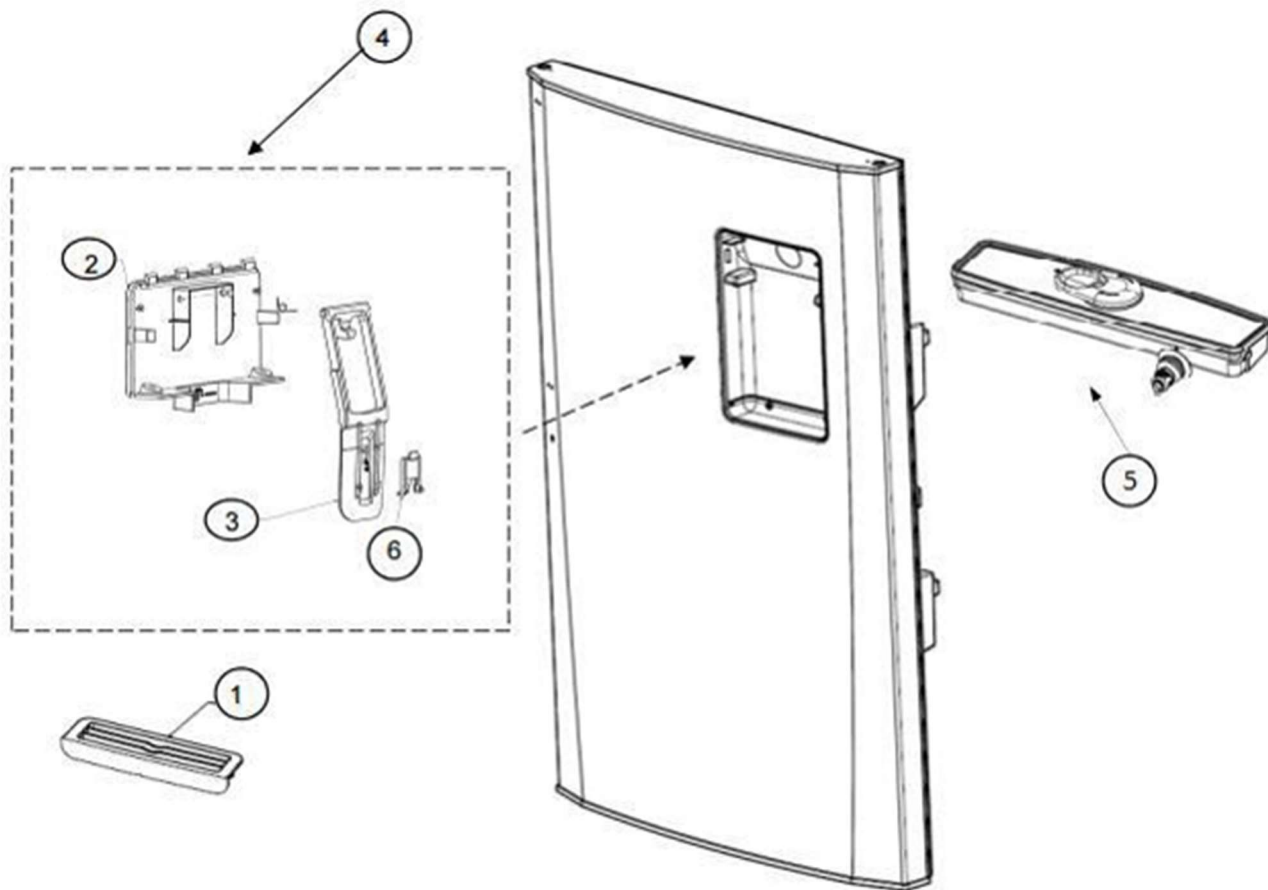

Marca		Whirlpool	
Capacidad		14 pies	
Color		Stainless Steel	
Dispensador			
R e f	Descripción	C a n t	Numero de Parte
1	Charola (Drip Tray)	1	W10514149
2	Cubierta (Fascia) del Dispensador	1	W10514135
3	Palanca de Agua	1	W10515048
4	Ensamble del Dispensador	1	W10634444
5	Tanque de Agua	1	W10415856
6	Candado (Lock, Water Dispenser)	1	W10515046